



INTERNATIONAL AMATEUR RADIO UNION

REGION 3

BANDPLAN



Revised: 16 October 2009

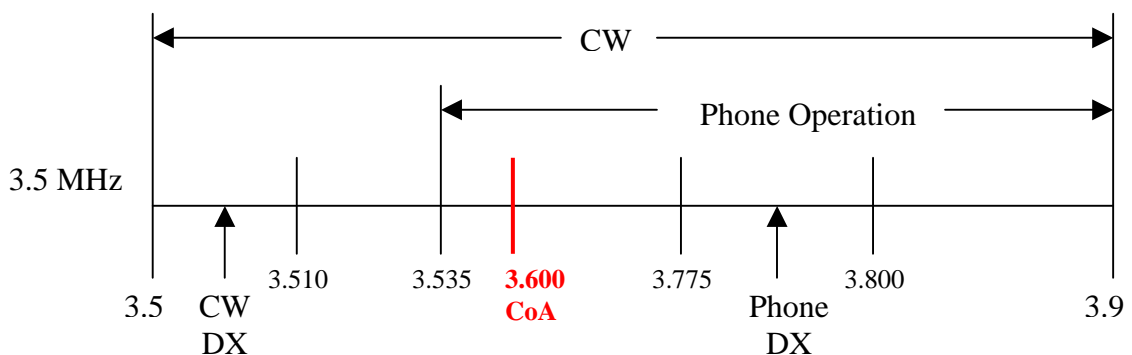
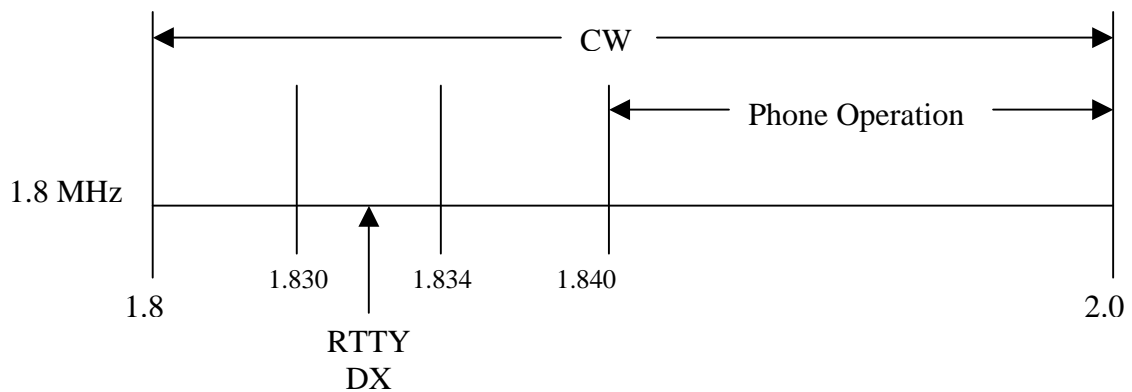
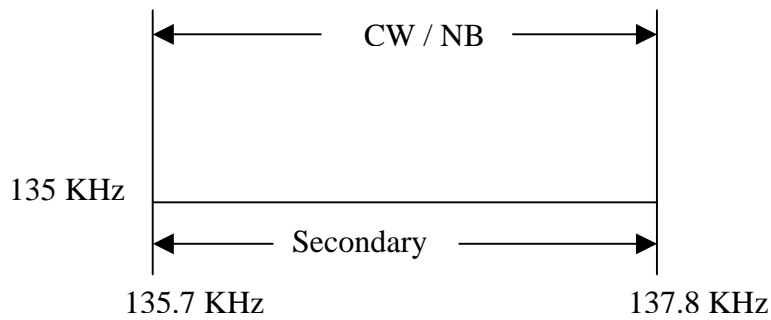

Note :

- ✓ Where the total band available nationally is 100 kHz or less, phone operation may commence at 3.525 MHz.
- ✓ Emergency CoA frequency 3.600 MHz (All Modes \pm 5 KHz)

-2-
IARU Region 3 Bandplan

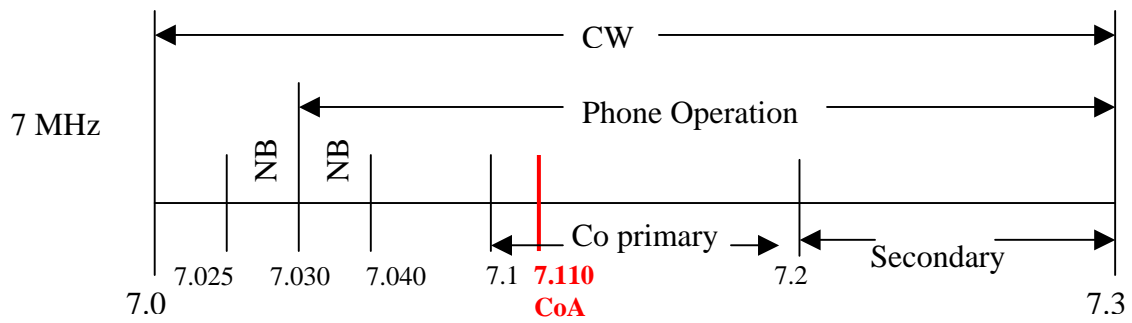

Note : Emergency CoA frequency 7.110 MHz (All Modes \pm 5 KHz)

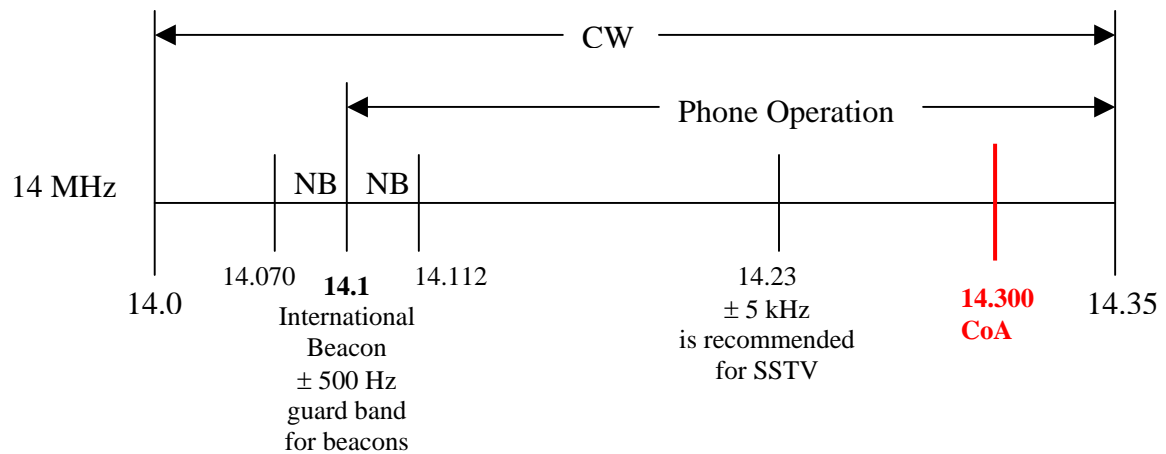
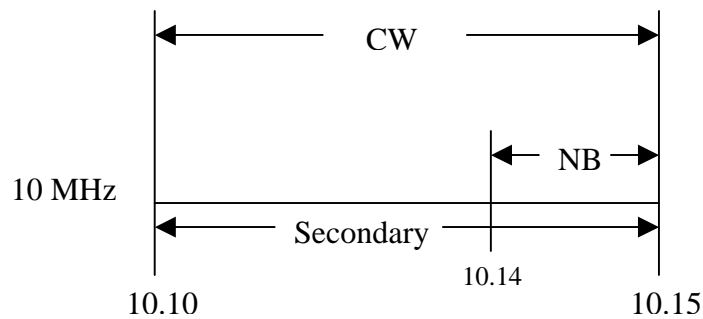

Note:

- ✓ Considering the dramatic increase in data mode usage on the 20 meter band, it is recommended that the sub-band for these classes of signals be 14.070 MHz to 14.112 MHz (with \pm 500 Hz at 14.100 MHz for beacons), and within that data sub-band the current practices of traditional data modes may continue up to 14.095 MHz with 14.095 to 14.112 MHz being reserved for other data modes including Packet.
- ✓ Emergency CoA frequency 14.300 MHz (All Modes \pm 5 KHz)

IARU Region 3 Bandplan

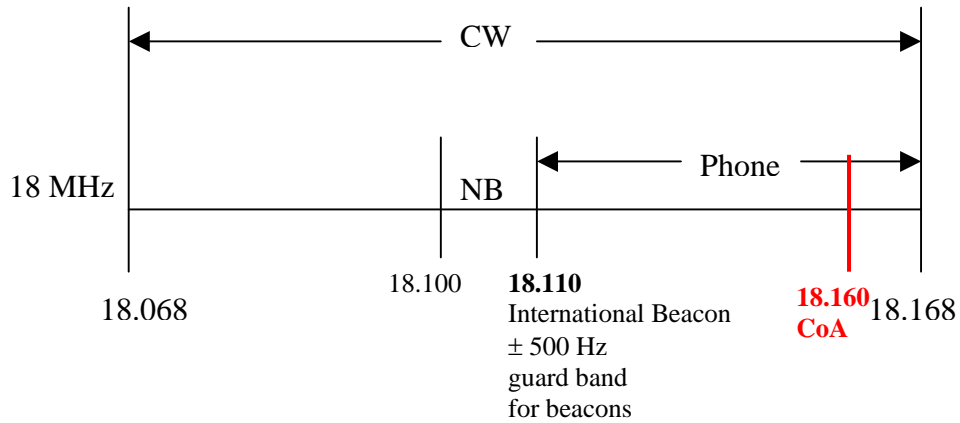

Note : Emergency CoA frequency 18.160 MHz (All Modes ± 5 KHz)

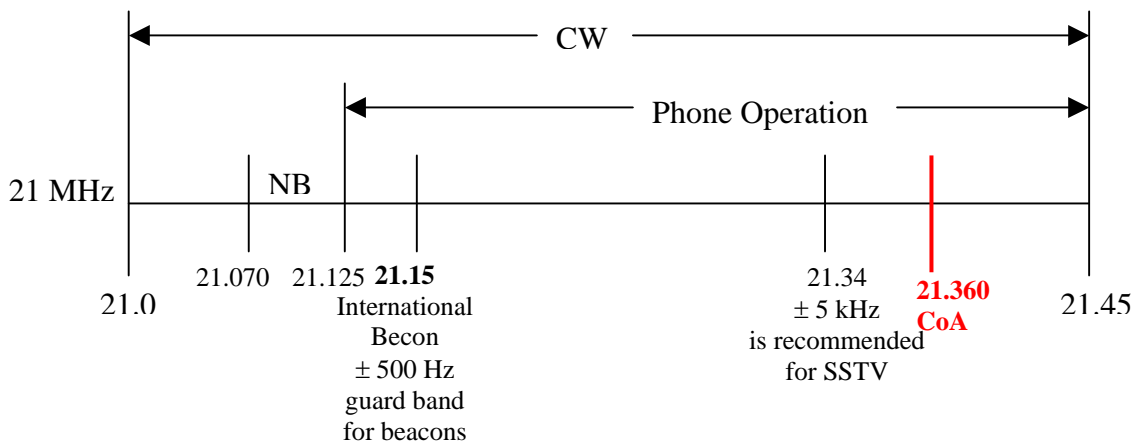

Note : Emergency CoA frequency 21.360 MHz (All Modes ± 5 KHz)

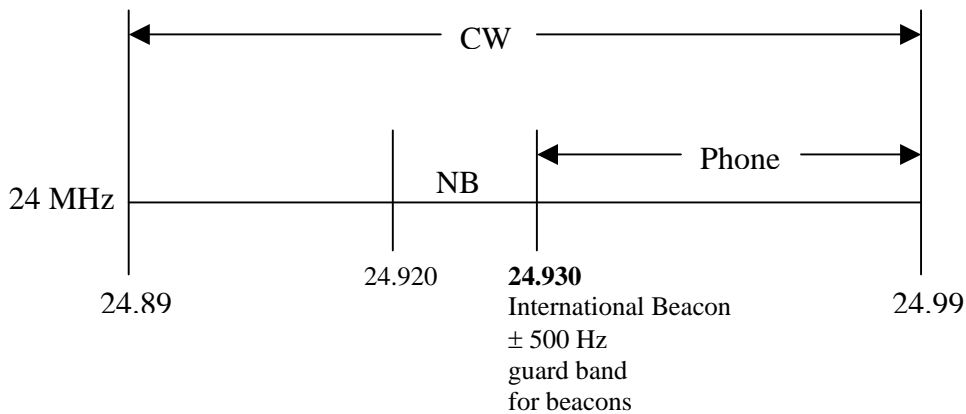

IARU Region 3 Bandplan

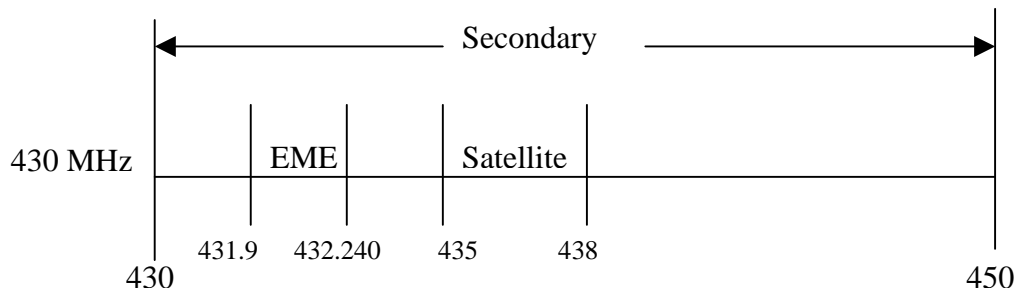
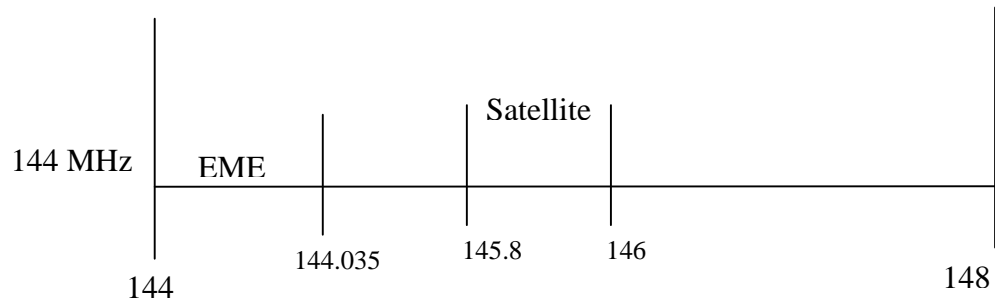
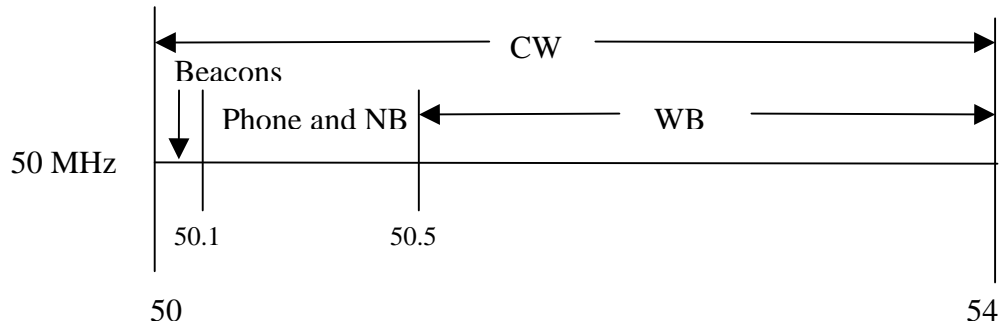
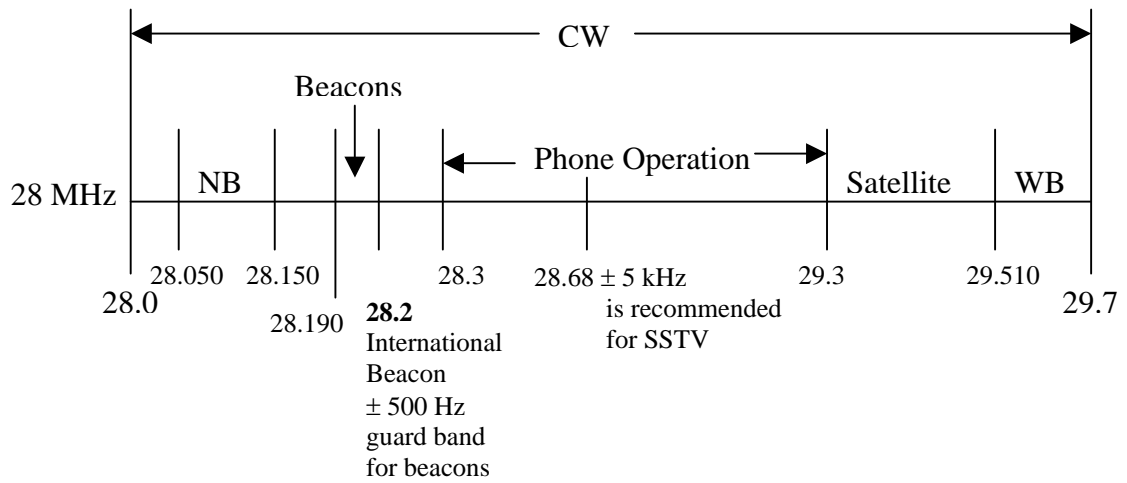

IARU Region 3 Bandplan

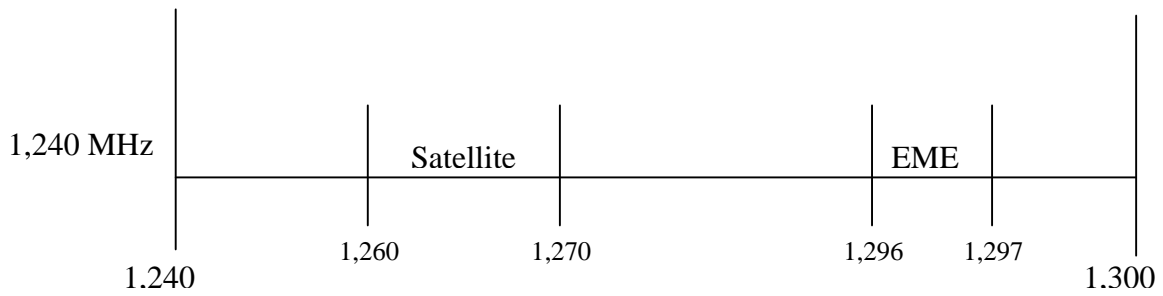

Bands above 1300 MHz:

Societies should consult with the amateur satellite community for proposed satellite operating frequencies before deciding local bandplans above 1300 MHz.

The Basic Principles Underlying the IARU Region 3 Bandplan:

- (1) In all cases of conflict between a bandplan and the national regulations of a country, the latter shall prevail.
- (2) Nothing in these bandplans shall be construed as prohibiting different national arrangements, provided that harmful interference is not caused to stations in countries operating in accordance with the regional bandplan.
- (3) Notwithstanding item 2 above, Member Societies of IARU Region 3 are strongly urged to use these regional bandplans as a basis for their national bandplans.

[Legends]

- CoA: Emergency Centre of Activity frequency
EME: Earth-Moon-Earth, Meteor Scatter, Auroral Scatter and other weak-signal
NB: Narrow band modes including CW, RTTY, Packet and modes with similar bandwidth not exceeding 2 kHz.
Phone: Phone operation includes SSTV, FAX and modes with similar bandwidth not exceeding 2 kHz.
Satellite: This segment should be kept clear of other operating modes.
Secondary: At 7.2 to 7.3 MHz, amateur stations shall not cause harmful interference to stations of the Broadcasting Service.
WB: Wide band modes including FM.

Adopted at the IARU R3 14th conference, Christchurch New Zealand 2009
